

WPF PUZZLE GP 2022

SOLUTION BOOKLET

1. Slalom [Branko Ćeranić] (13 points)

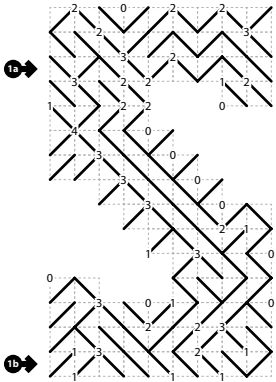

2-3. Shikaku [Marko Tanasić] (7, 15 points)

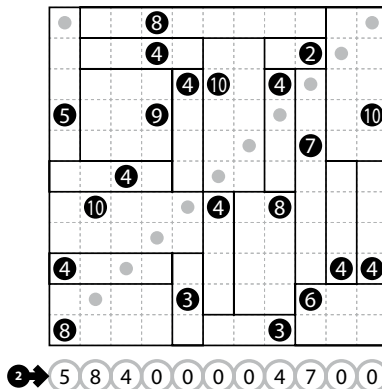

2 → 5 8 4 0 0 0 0 4 7 0 0

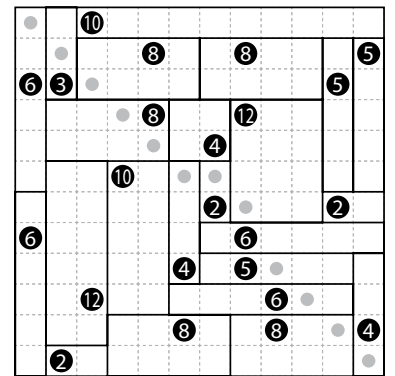

3 → 6 3 8 8 8 4 2 2 5 6 8 4

4-5. Star Battle [Marko Tanasić] (9, 14 points)

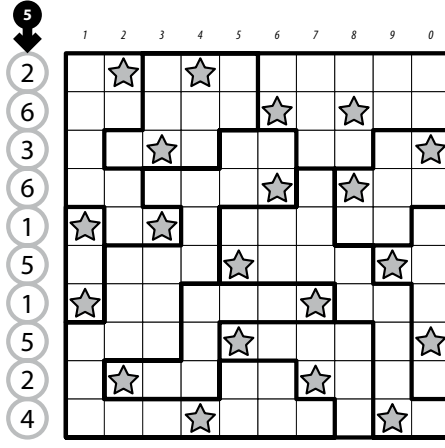
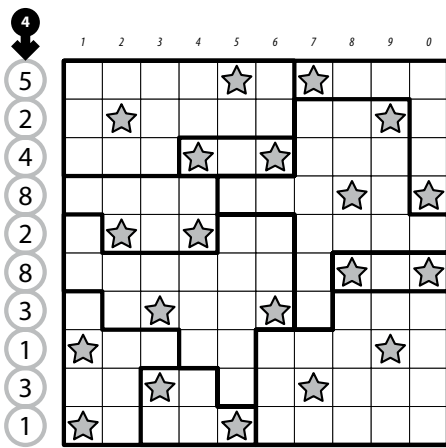

8-9. Sashigane [Nikola Živanović, Marko Tanasić] (23, 19 points)

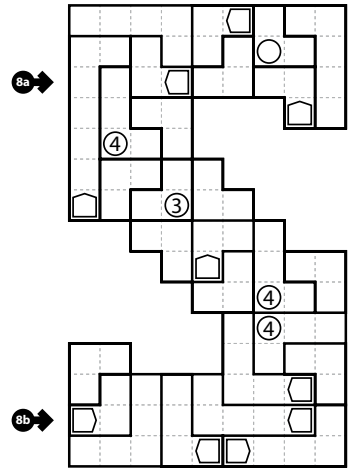

6-7. Satogaeri [Marko Tanasić] (14, 15 points)

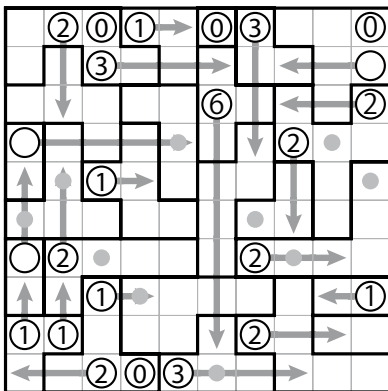

6 → 2 2 0 1 4 3 0 2 0 0

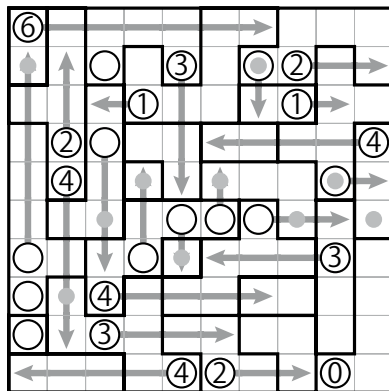

7 → 5 4 3 2 1 1 1 2 1 0

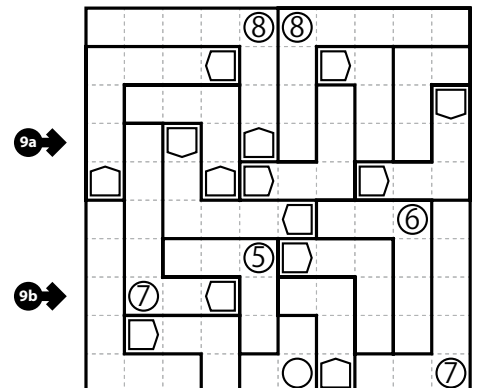

9a →

9b →



10. Sudoku (classic) [Nikola Živanović] (20 points)

10a →

2	4	1	8	7	6	5	9	3
6	8	7	3	5	9	4	1	2
9	3	5	1	2	4	7	6	8
5	2	4	9	3	1	8	7	6
8	1	6	2	4	7	3	5	9
7	9	3	6	8	5	1	2	4
4	7	2	5	6	8	9	3	1
3	5	9	4	1	2	6	8	7
1	6	8	7	9	3	2	4	5

10b →

11. Sudoku (Serbian Frame) [Zoran Tanasić] (66 points)

11a →

	10	17	3	8	9	9		
3	4	1	2	8	3	5	6	7
	6	3	5	4	7	9	8	1
17	7	9	8	2	6	1	4	5
11	3	2	9	1	4	7	5	8
15	1	8	7	3	5	6	9	2
10	5	4	6	9	8	2	7	3
9	9	5	4	7	1	3	2	6
9	8	6	3	5	2	4	1	9
8	2	7	1	6	9	8	3	4
	14	10	16	5	9	9		

11b →

12-13. ShakaShaka [Nikola Živanović, Marko Tanasić] (29, 30 points)

12a →

1			2	1				1	
			1						
			1						
			2	0	2				
						0			
						2			
3			1	2				1	

12b →

14. Snake (length, ends) [Nikola Živanović] (21 points)

14a →

	3	5	5	4	5	5	5	6	3	4
3										
6										
4										
6										
5										
5										
1										
14b →	6									
	3									
	6									

13a →

0									
			4						0
0				1					
				3					
				2					
							4		
1									2
0							2		

13b →

15. Starry Sky (one or more) [Branko Ćeranić] (34 points)

15a →

	2	0	2	2		2	0	2	2
		↘		↓		↗			↙
3			☆	→	→	☆			☆
4		↓		☆	☆		☆		☆
				↖	↘				↑
2				☆	☆			←	
3		↗		☆		☆			☆
3	☆			↖	☆			☆	
				←					↖
1			☆		←				
2	☆			☆		↗	↑		↖

15b →

16-17. Suguru [Branko Ćeranić] (21, 30 points)

16a →

2	1	5	4	5	1	2	3	4	1	5	1
3	4	2	1	3	4	5	1	5	3	2	3
1	5	3	4	5	1	2	3	2	4	1	4
2	4	2	1	2	3	4	5	1	5	3	2
1	3	5	3	4	5	2	3	4	2	4	5

16b →

17a →

5	1	2	5	4	3	5	4	3
2	3	4	3	2	1	2	1	2
5	1	2	5	4	3	4	5	3
4	3	4	3	1	5	1	2	1
1	2	1	2		3	4	3	5
4	5	3	5	4	1	2	1	4
2	1	4	2	3	5	3	5	2
5	3	5	1	4	2	4	1	4
1	4	2	3	5	1	5	3	2

17b →



18. Shape Division [Nikola Živanović] (26 points)

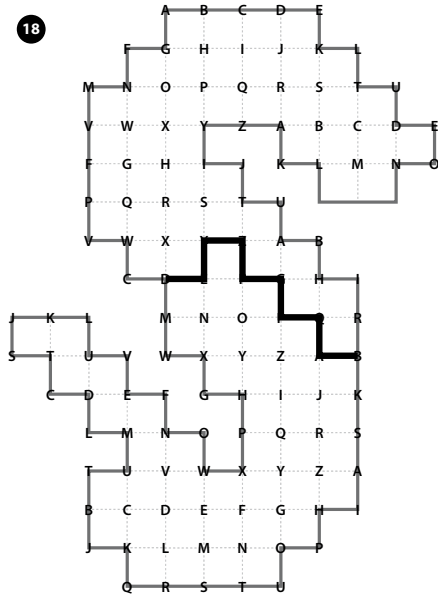

19. Spiral Galaxies [Nikola Živanović] (62 points)

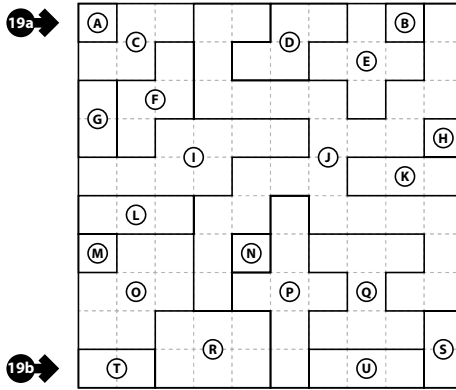

20. Sombor [Nikola Živanović] (44 points)

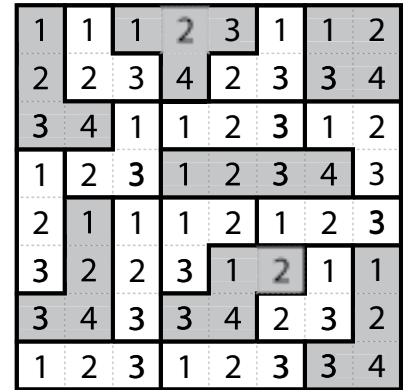

21. Slitherlink [Marko Tanasić] (60 points)

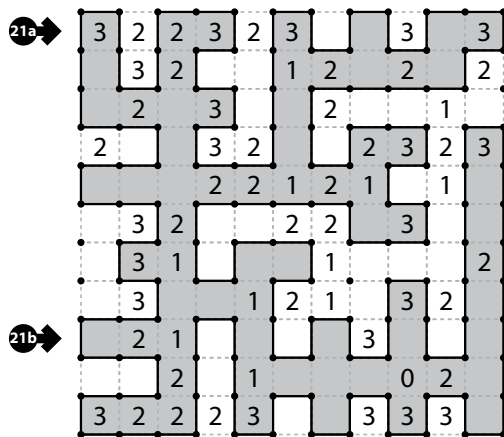

22. Stostone [Nikola Živanović] (77 points)

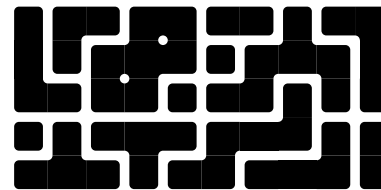
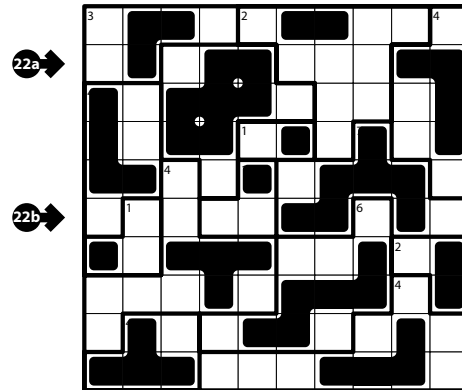

23. Statue Park [Čedomir Milanović] (94 points)

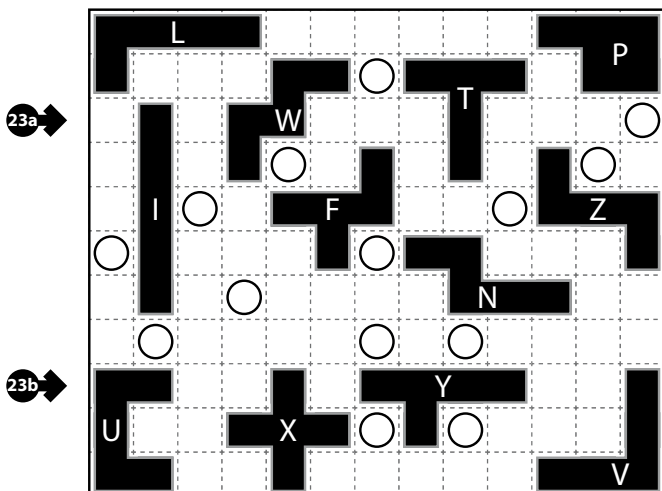

24. Scrabble [Čedomir Milanović] (99 points)

