

WPF PUZZLE GP 2022 SOLUTION BOOKLET

1. Snake (Cipher) [Kartal Nagy] (47 points)

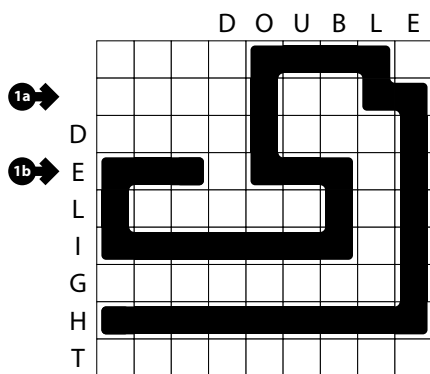

2. Loop [Kartal Nagy] (7 points)

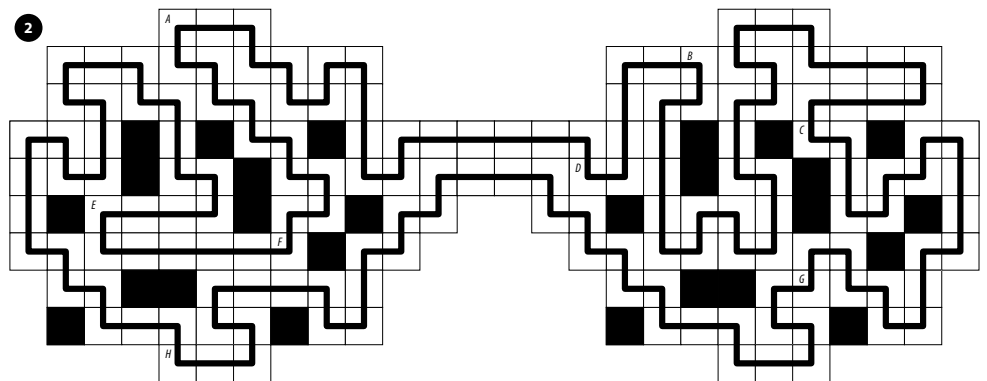

3. Snaky Loop (Nonogram) [Zoltán Horváth] (48 points)

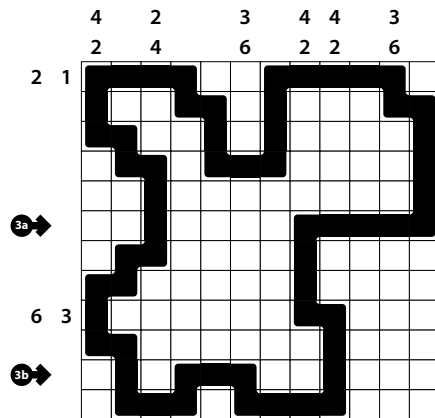

4. Loop (Double or Nothing) [Zoltán Horváth] (58 points)

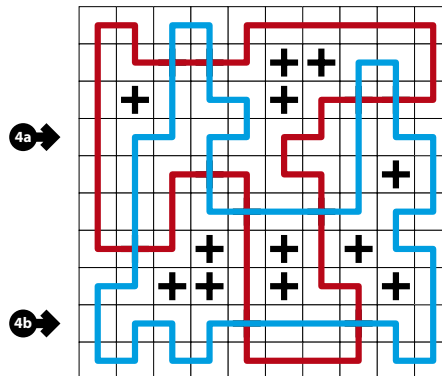

5. Tapa [Kartal Nagy] (18 points)

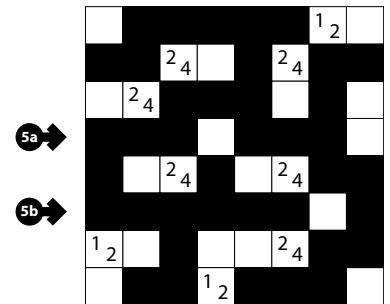

6. Twopa [Zoltán Horváth] (42 points)

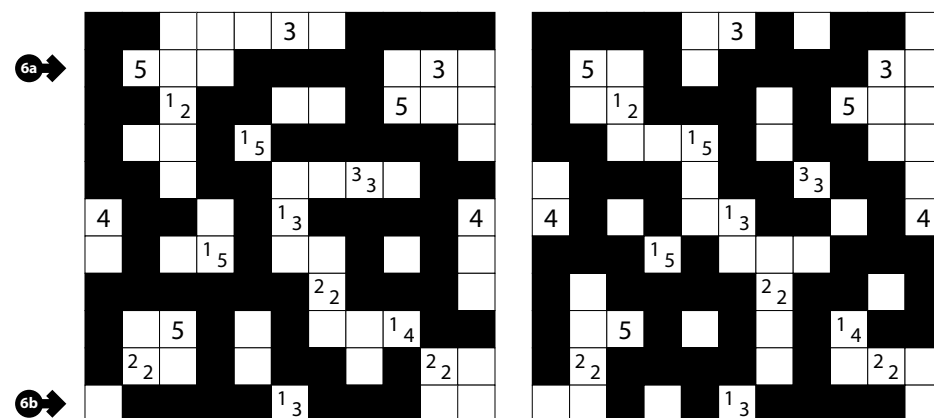

7. Cross the Streams [Zoltán Horváth] (25 points)

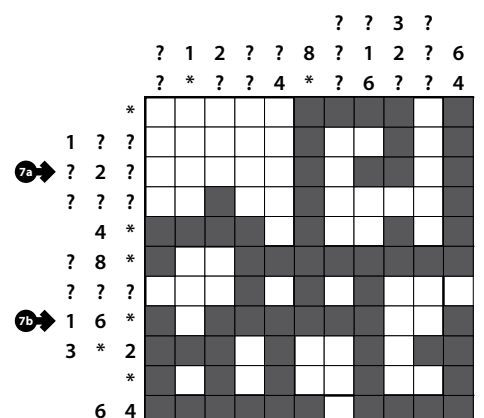



8. Kurotto [Zoltán Horváth] (53 points)

8a →

8b →

9. TomTom [Kartal Nagy] (36 points)

{1..6}

5	1	6	3	2	4
2	3	4	1	2	6
6	3	4	2	5	1
1	5	2	6	4	3
4	2	5	1	3	6
2	6	3	4	5	1

9a →

9b →

10a →

10b →

10. Skycrapers (Double) [Zoltán Horváth] (74 points)

		3		4		3			1		
	2	2	3	1	1	3	4	4			
2	3	3	4	1	2	4	2	1	3		
2	3	4	1	2	4	3	2	1	4		
4	1	2	2	3	4	4	1	3	2		
	4	3	2	4	3	1	1	2	3		
	4	4	1	2	3	1	3	2	3		
3	2	1	3	4	1	2	4	3	2		
2	1	1	4	3	2	2	3	4			
	3	2				3					

11. Tents (Double) [Zoltán Horváth] (44 points)

	1	2	3	4	5	6	7	8	9	10
	3	2	3	4	1	3	2	3	2	3
11	1	3	1	1	6	2	6	1	1	4
4	2	1	3	2	2	2	2	2	2	2
1	3	1	2	1	2	1	2	1	2	1
1	2	1	2	1	2	1	2	1	2	1
6	2	1	2	1	2	1	2	1	2	1
2	2	1	2	1	2	1	2	1	2	1
6	2	1	2	1	2	1	2	1	2	1
1	5	1	2	1	2	1	2	1	2	1
1	2	1	2	1	2	1	2	1	2	1
4	2	1	2	1	2	1	2	1	2	1

12. Kropki [Gyula Slenker] (99 points)

12a →

4	6	1	3	5	8	2	7
6	3	5	7	2	4	8	1
8	1	3	5	7	2	6	4
5	2	7	1	3	6	4	8
7	4	2	8	6	3	1	5
2	7	4	6	8	1	5	3
1	5	8	2	4	7	3	6
3	8	6	4	1	5	7	2

12b →

13. Magnets [Kartal Nagy] (38 points)

		4	1	1	2	2		
		2	2	2	4	4		
		+	-		+	-	+	-
1	2				-	+	-	
4	2	+			+	-	+	-
		+					+	-
2	1	+					-	+
2	4	-	+	-	+	-		-
		+	-	+	-	+	-	+
			-	+	-		+	-

13 → P P X N X X X P

14. Magnets (Double Length) [Zoltán Horváth] (78 points)

	+	2	2	2	2	4	3	2	3	2	3	2	3
		-	2	2	3	3	3	2	2	3	2	3	2
3	2	-	+				+						
3	2												
4	3	+	-	+		+							
3	2												
3	4		+	-									
2	3												
3	2												
4	3												
2	4		+										
1	3												
2	2												
3	3												

14 → P N N N X X N N

15. S-Policy (Double) [Pál Madarassy] (58 points)

15a →

15b →