

# WPF PUZZLE GP 2023 SOLUTION BOOKLET

## 1. Hundred [Deyan Razsadov] (24 points)

1a →

36	35	29
56	8	36
8	57	35

1b →

1c →

## 2. Balance [Deyan Razsadov] (49 points)

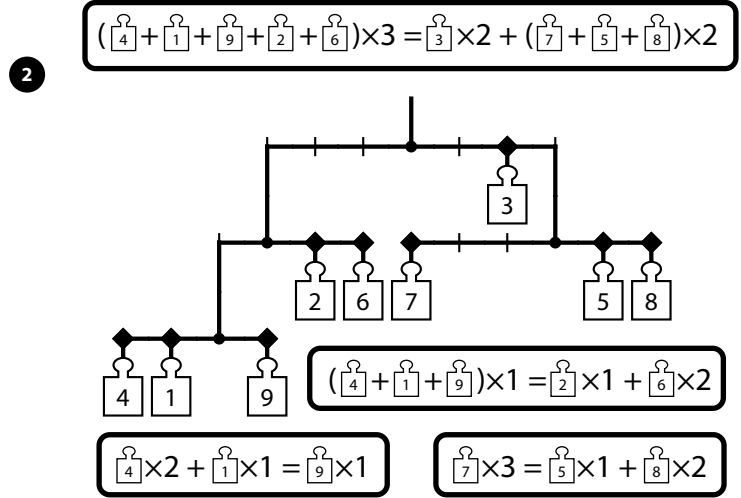

## 3. Arrows [Deyan Razsadov] (46 points)

3a →

↓	↘	↓	↓	↓	↙		
↘	2	2	4	3	3	1	↙
↘	3	2	3	6	1	2	↙
→	7	5	5	5	6	4	←
↗	4	6	3	4	4	4	←
↗	5	1	4	4	1	2	↖
↗	2	3	2	4	2	1	↖
↑	↑	↖	↑	↖	↑		

3b →

## 4. Star Battle [Alexander Angelov] (57 points)

4

4			★					★	
2	★					★			
4			★					★	
6					★		★		
2	★								★
6					★		★		
1	★	★							
5				★		★			
3		★						★	
1	★			★					

## 5. Double Choco [Alexander Angelov] (50 points)

			3						1
	3					2		●	
			6	●					
						9	●		
									3
	5							1	
									●

5 → 2 3 5 6 9 3 1 4 4 2



### 6. Pentominous [Alexander Angelov] (51 points)

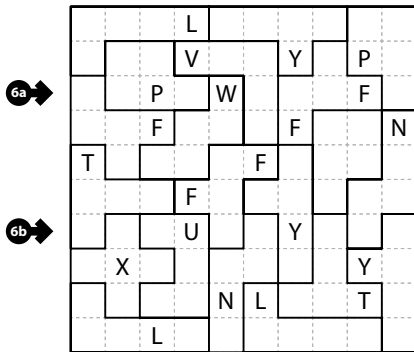

### 7. Mastermind [Alexander Angelov] (35 points)

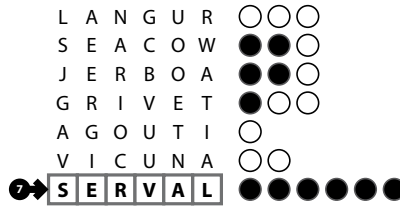

### 8. Kropki [Alexander Angelov] (27 points)

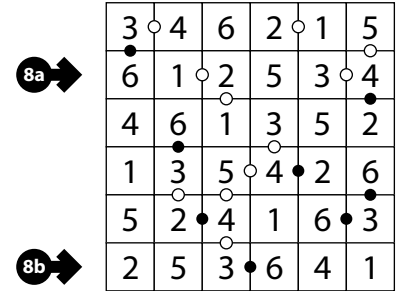

### 9. Kropki (Mastermind) [Alexander Angelov] (99 points)

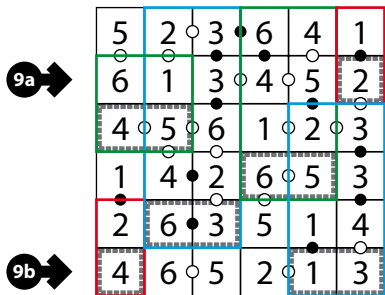

### 10. Cave [Deyan Razzadov] (37 points)

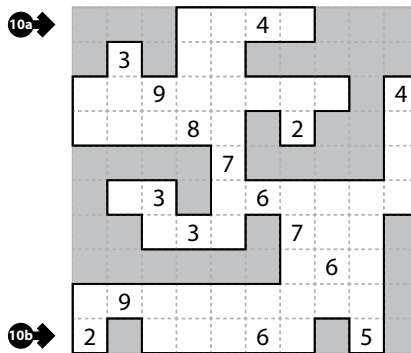

### 11. Slitherlink [Deyan Razzadov] (43 points)

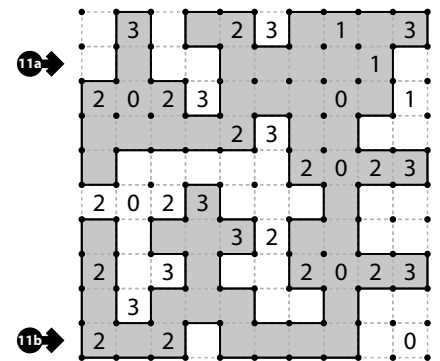

### 12. Cave (Inside+Outside) [Deyan Razzadov] (53 points)

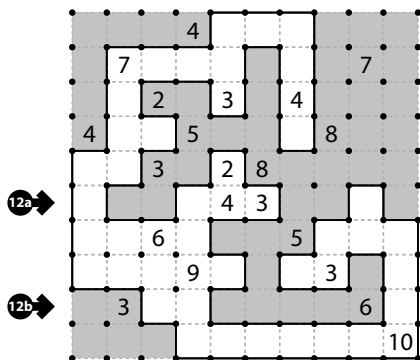

### 13. Akari [Deyan Razzadov] (12 points)

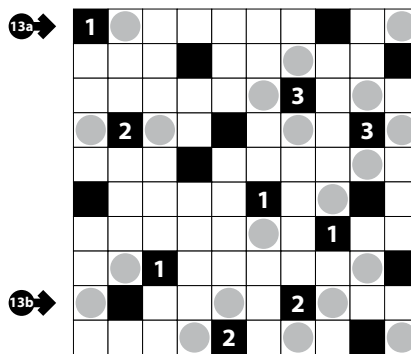

### 15. Scrabble (Akari) [Alexander Angelov] (103 points)



### 14. Scrabble [Alexander Angelov] (20 points)

