

WPF PUZZLE GP 2023 SOLUTION BOOKLET

1-3. Balance (24, 19, 57 points)

1

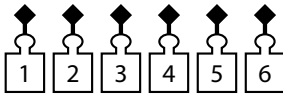
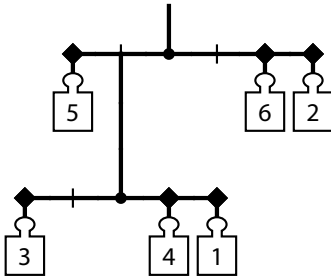

2

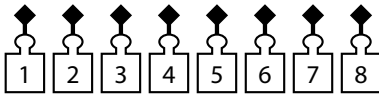
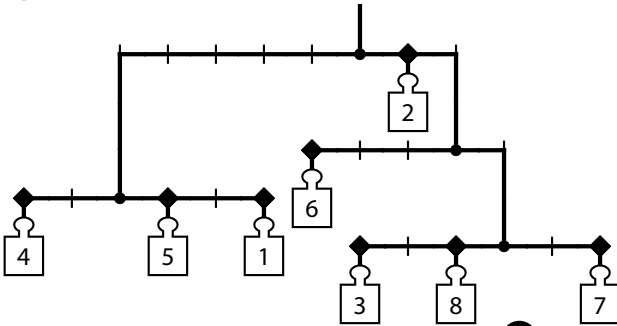

4-6. Slitherlink (22, 27, 37 points)

4a

4b

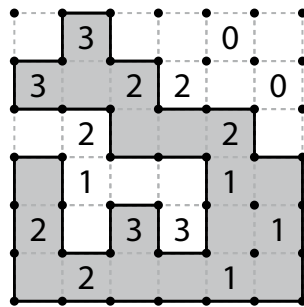

5a

5b

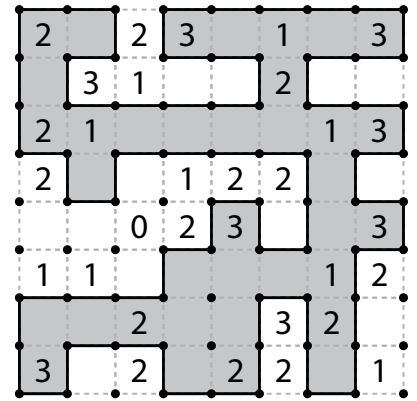

6a

6b

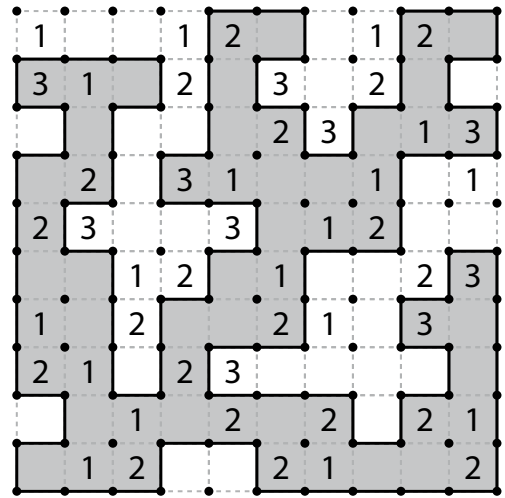

3

